

outdoor
Home[®]

9ft Round Solar Market Umbrella

Assembly & Care Instructions

Item Number:
3982594, 3988512
3988513, 3988514
Model: UMB-879210



**IMPORTANT: RETAIN FOR FUTURE REFERENCE
READ CAREFULLY**

For assistance with assembly, parts, or customer service, please call:

TOLL FREE: 1-855-880-7205

8am - 5pm, Monday through Friday, Eastern Standard Time

Do Not Return To Store

FOR OUTDOOR USE ONLY

Designed in USA

Made in China

Contents

Package Contents	2
Assembly and Use	3 - 4
Battery Replacement	4 - 5
Replacement Parts	5
Care and Maintenance	6
Warning and Cautions	6
Warranty	6

Compare carton contents with package contents list. If any part is missing or damaged, call customer service TOLL FREE at 1-855-880-7205 for replacement parts or further assistance.

Package Contents

Please lay out all parts prior to assembly to make sure all parts are present.

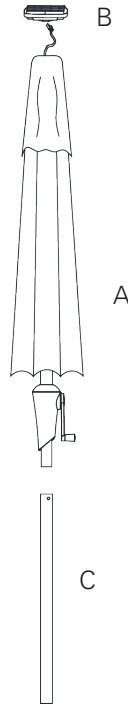

Part	Description	Quantity
A	Umbrella Frame with Canopy	1
B	Solar Panel (located in protective packaging)	1
C	Bottom Pole	1



CAUTION: Do not use sharp tools or equipment such as a knife or scissors when removing the protective material, as it may damage the product.

Assembly and Use



INFORMATION: Please remove the plastic film on the solar panel. This protective film is to prevent damage during shipping. Failure to remove the film will result in the solar panel not functioning properly.

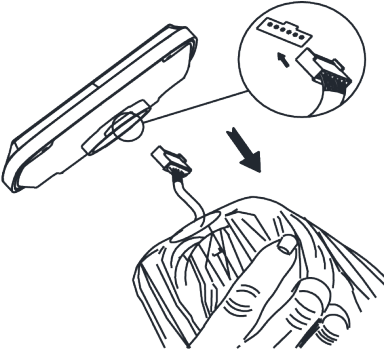

Step 1: Insert plug into socket on backside of solar panel (B).

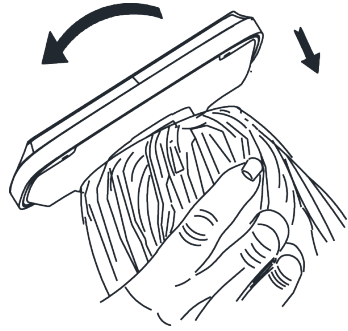

Step 2: Align solar panel (B) with umbrella cavity (A), hiding wires inside. Turn solar panel clockwise (to right) to lock in to place. Do not over-tighten.

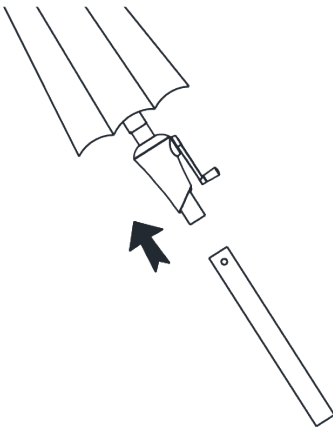

Step 3: Slide bottom pole (C) on to umbrella frame (A), while pressing snap button, until the snap button locks into position.

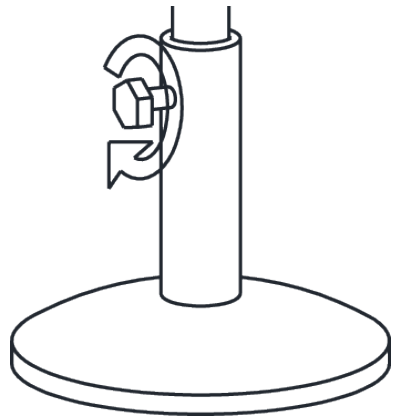

Step 4: Insert umbrella into a heavy umbrella base (not included). Tighten locking nut on side of base to safely secure umbrella.

Assembly and Use (cont'd)

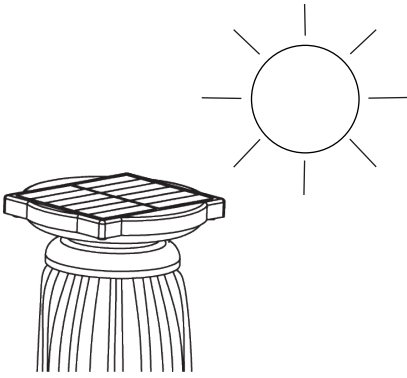

Step 5: Put solar umbrella in direct sunlight for **8 hours** to charge battery for **first use**. Charging for less time will shorten lifespan of battery and decrease performance.

 To charge, ensure umbrella is in direct sunlight and the switches on umbrella rib are in OFF position. Solar panel will not recharge if lights are switched to ON position.

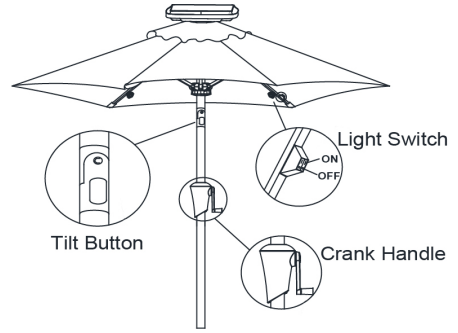

Step 6: Turn Crank Handle in clockwise direction (to right) until canopy is fully opened. Turn Crank Handle in opposite direction to close canopy and secure with attached strap. Umbrella must not be tilted when closing.

Tilt canopy by pushing Tilt Button on pole while manually leaning top section of umbrella pole left or right.

Press Light Switches to turn ON/OFF solar lights and hub light individually or together.

Battery Replacement

We recommend that you change the battery in your solar light umbrella every year, or when you feel that the light output is diminished.

- For best results, use 18650 Lithium (1500mAh) rechargeable battery.
- Failure to insert batteries in the correct polarity, as indicated in the battery compartment, may shorten the life of the batteries or cause batteries to leak.
- Do not use Alkaline or Standard Carbon-Zinc batteries as they are not rechargeable.
- Do not mix Alkaline, Standard (Carbon-Zinc) or Rechargeable (Nickel Cadmium or Nickel Metal Hydride) batteries.
- Do not mix old and new batteries.
- Do not dispose of batteries in a fire.
- Batteries should be recycled or disposed of as per state and local guidelines.

Battery Replacement (cont'd)

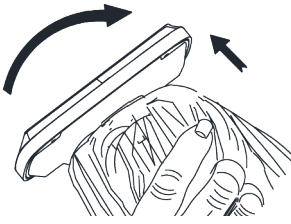

Step 1: Twist counter clockwise (to left) and remove solar panel from top of umbrella.

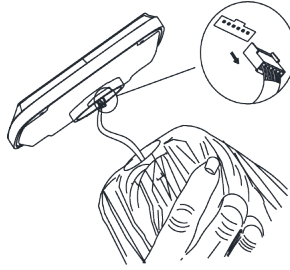

Step 2: Pull plug out of socket from under solar panel by holding plugs, not wires.

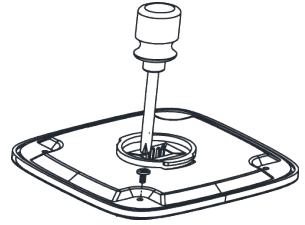

Step 3: Place solar panel on flat, soft surface. Loosen screws on solar panel lid.

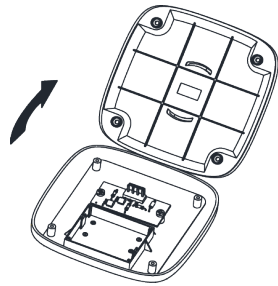

Step 4: Carefully open solar panel and set aside lid. Replace battery, matching the +/- on battery with the +/- on solar panel.

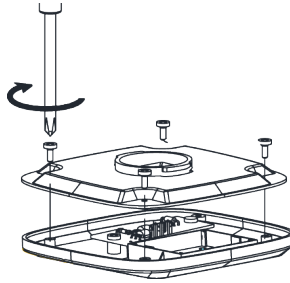

Step 5: Carefully replace solar panel lid. Align screw holes and replace screws. Do not over-tighten screws.

Your solar umbrella is ready to use again!

To charge, ensure umbrella is in direct sunlight and the switches on umbrella rib are in OFF position. Solar panel will not recharge if lights are switched to ON position.

Replacement Parts

For replacement parts, call our customer service department at: 1-855-880-7205, 8am - 5pm EST, Monday - Friday.

Part	Description	Re-order Number
A	Umbrella Canopy	CAN-9M8RBP-T-IC-RDL-CSTS-PCT
B	Solar Panel	SOL-PEZLT2-T
C	Bottom Pole	BMP-38SSN-DT-BWN-T

U.S. Patent No. 7,604,015 and U.S. Patent No. 7,533,679.

Care and Maintenance

- Use mild soap and warm water to clean canopy. Rinse with water and dry thoroughly. Do not machine wash. Do not iron. Air dry the canopy thoroughly before storing for extended periods of time. Make sure the canopy is completely open during drying process to prevent shrinkage.
- If crank becomes too hard to turn, check to see if rope has slipped off pulley. If you continue to crank, the rope or crank handle may break. If parts have broken, call customer service, toll free: 1-855-880-7205 8am-5pm, Monday - Friday, Eastern Standard Time.
- Placement of umbrella over or near a swimming pool will cause premature fading not covered under our warranty.

Warning and Cautions



DANGER: Keep children out of the assembly area during assembly.



WARNING: Read the entire instructions before beginning and follow the steps outlined. Failure to assemble and install as instructed could result in the umbrella tipping over causing personal injury and/or property damage.



WARNING: Do not use this umbrella during periods of high winds and rain. Failure to do so may result in personal injury and/or damage.



CAUTION: Assemble and use umbrella on flat ground.



INFORMATION: Be sure to secure and/or weight the base of the umbrella.



INFORMATION: Close the umbrella and use the canopy storage straps or ties when umbrella is not in use.



INFORMATION: Schematics in this manual are for assembly and operation illustration only. They may differ from the umbrella's actual appearance.

Warranty

90 DAY WARRANTY

This product is covered under a manufacturer's 90 day warranty from date of purchase against defects in materials and workmanship. This warranty does not cover damage due to neglect, abuse, or weather related damage. For full warranty disclosure, call customer service toll free at 1-855-880-7205.

NOT COVERED UNDER WARRANTY

This warranty excludes the following: acts of nature (i.e. wind, fire, or freeze); damage caused by improper assembly, accident, disaster, misuse, abuse, negligence and discoloration or fading of the finish or wicker as a result of exposure to the elements. Product not intended for commercial use. This warranty gives you specific legal rights, and you may also have other rights which vary from state to state.

Enjoy!



outdoor **Home**®

customer service

TOLL FREE: 1-855-880-7205

8am - 5pm, Monday through Friday, Eastern Standard Time